

FIREPLACE INSERT BEF FLAT 9 CL IN ACCORDANCE WITH EN 13 229

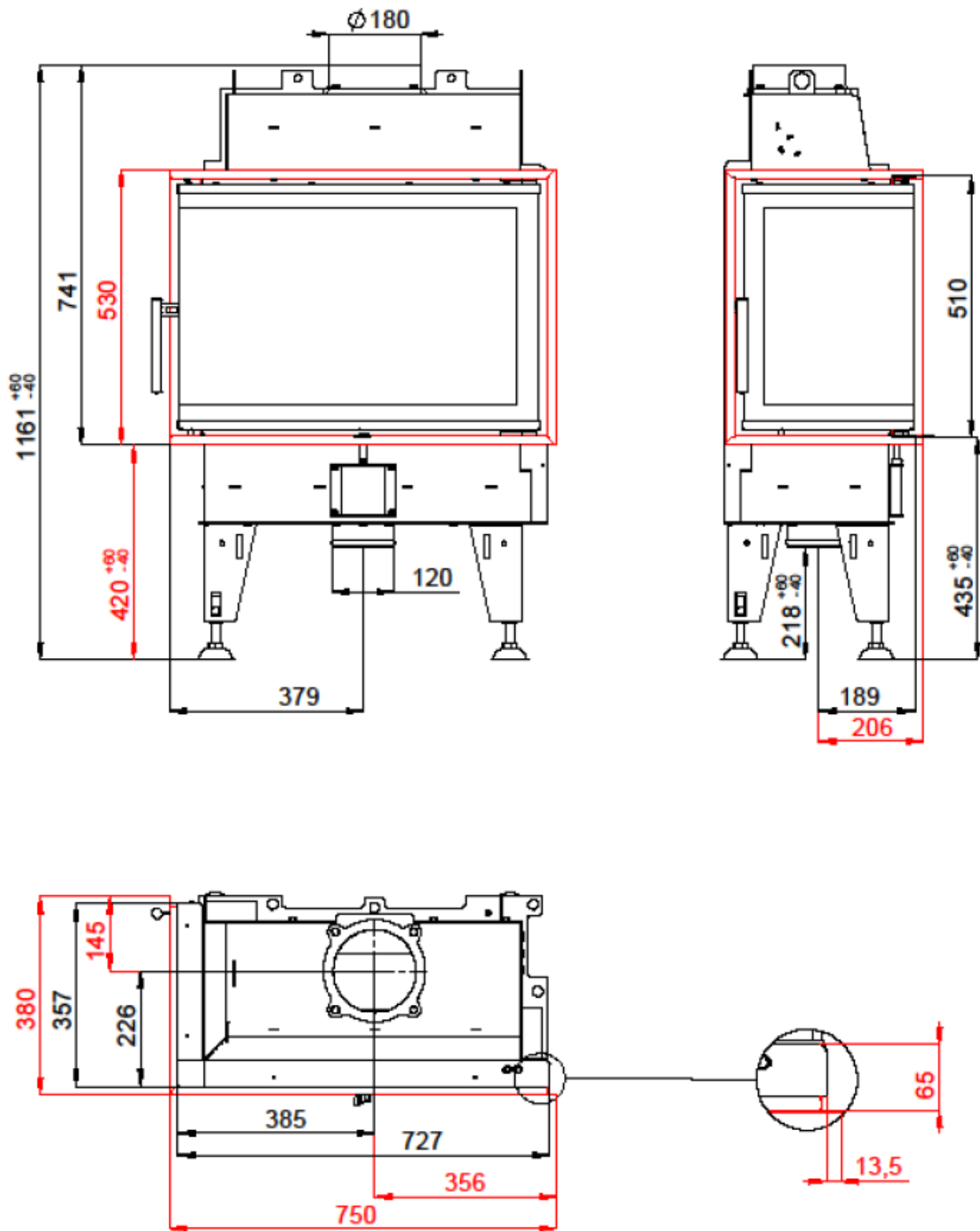

FIREPLACE INSERT BEF FLAT 9 CL **IN ACCORDANCE WITH EN 13 229**

Technical data:

Nominal heat output	kW	8
Efficiency	%	85
Volume flow of combustion products	g/s	6
Flue-gas temperature	°C	212
Min. feed pressure at nominal heat output	Pa	12
Fuel		wood (beech logs)
Fuel consumption per hour	kg/h	2,54
CO emission in burnt gas (in relation to 13% O ₂)	%	0,0932
Dust in flue-gas (in relation to 13% O ₂)	mg/Nm ³	16
Smoke flue diameter	mm	180
Weight	kg	123

Set of carcon firebox:

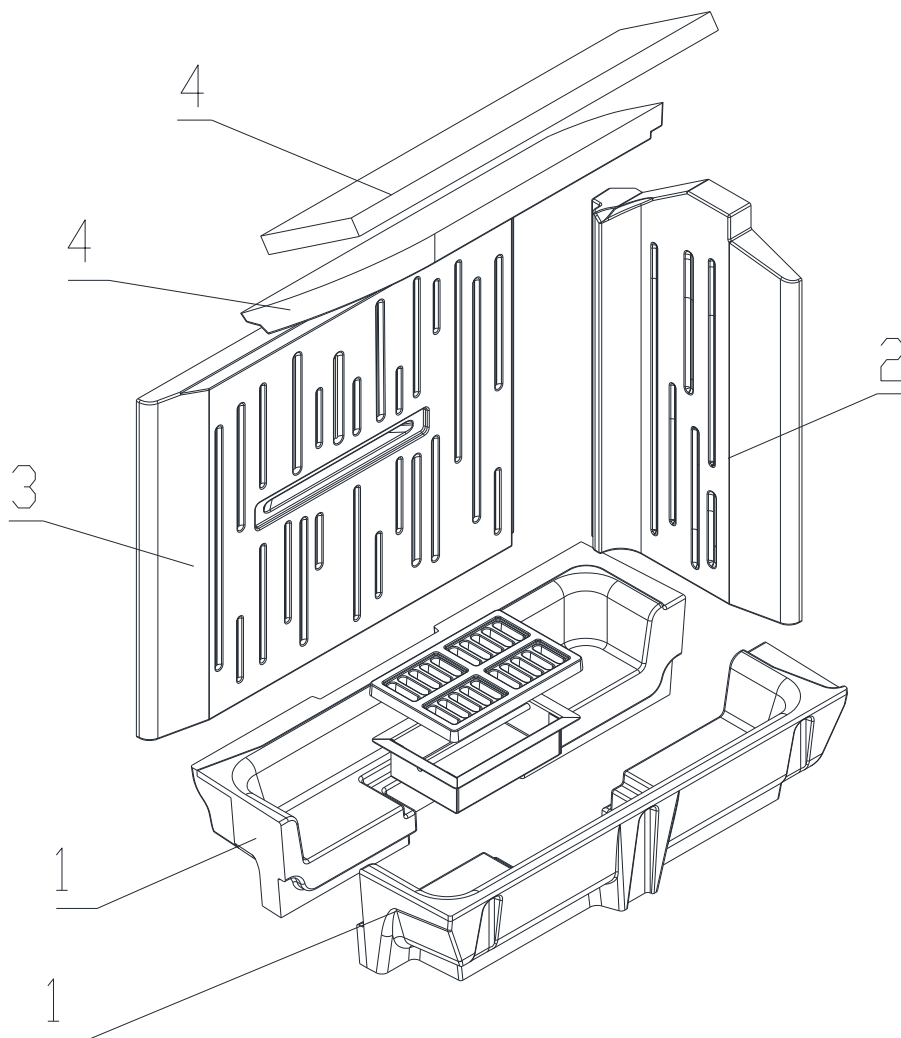

List of spare parts:

- 1. Bottom**
- 2. Side piece**
- 3. Back**
- 4. Deflector**
- 5. Cast iron grate**
- 6. Ashtray**

For details see Installation and Service Instructions.